

BC

Basic Pedestal



Self Priming Centrifugal Pump

Models 03C11-B and 03C31-B

Size 3" x 3"

PUMP SPECIFICATIONS

Size: 3" x 3" (76 mm x 76 mm) NPT - Female.

Casing: Ductile Iron 60-40-18.

Maximum Operating Pressure 75 psi (517 kPa).*

Enclosed Type, Five Vane Impeller: Brass 85-5-5-5.

Handles 7/16" (11,1 mm) Diameter Spherical Solids.

Impeller Shaft: (03C11-B) Stainless Steel 303/304.

(03C31-B) Carbon Steel 1045.

Replaceable Vane Plate: Gray Iron 30.

Pedestal: Gray Iron 30.

Seal Plate: Ductile Iron 60-40-18.

Radial and Thrust Bearings: Single Row Ball Type.

Bearing Lubrication: Grease.

Flanges: (03C11-B) Gray Iron 30.

(03C31-B) Ductile Iron 60-40-18.

Gaskets: (03C11-B) PTFE.

(03C31-B) Cork ^w/Nitrile Binder NC710.

Hardware: Standard Plated Steel.

Optional Equipment: All Iron Construction.



*Consult Factory for Applications Exceeding Maximum Pressure and/or Temperature Indicated.

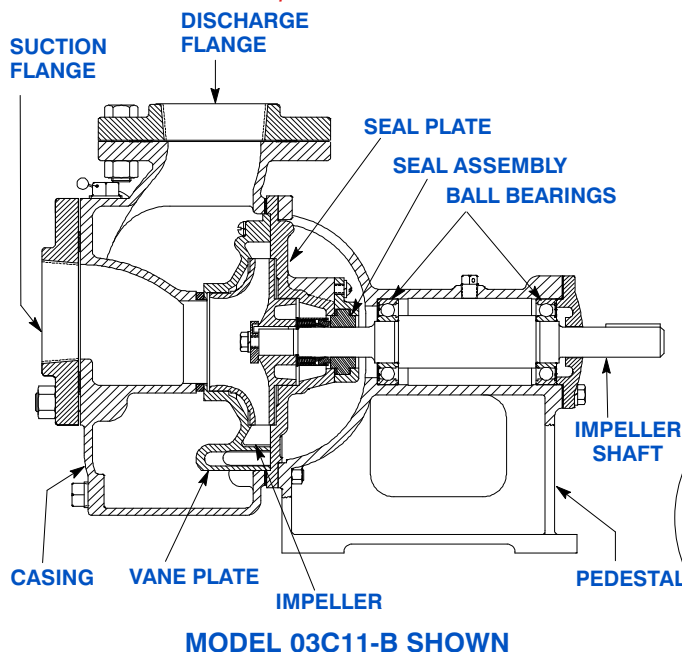

SEAL DETAIL 03C11-B:

Type 9, Mechanical Self-Lubricated. Rotating Face is Carbon. Stationary Face is Ceramic. PTFE Elastomers. Stainless Steel 316 Cage and Spring. Maximum Temperature of Liquid Pumped, 160°F (71°C).*

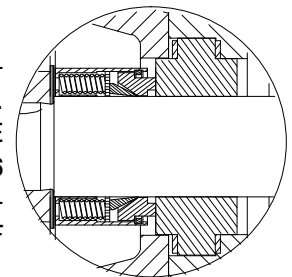

SEAL DETAIL 03C31-B:

Type 21, Mechanical. Self-Lubricated. Carbon Rotating Face. Ni-Resist Stationary Face. Fluorocarbon Elastomers (DuPont Viton® or Equivalent). Stainless Steel 18-8 Cage and Spring. Maximum Temperature of Liquid Pumped, 160°F (71°C).*

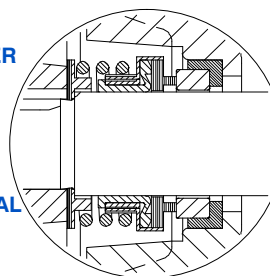

THE GORMAN-RUPP COMPANY • MANSFIELD, OHIO

GORMAN-RUPP OF CANADA LIMITED • ST. THOMAS, ONTARIO, CANADA

www.grpumps.com

Specifications Subject to Change Without Notice

Printed in U.S.A.

Specification Data

APPROXIMATE
DIMENSIONS and WEIGHTS

NET WEIGHT:
SHIPPING WEIGHT:
EXPORT CRATE:

122 LBS. (55 KG.)
132 LBS. (60 KG.)
3.6 CU. FT. (0,1 CU. M.)

SECTION 30, PAGE 1300

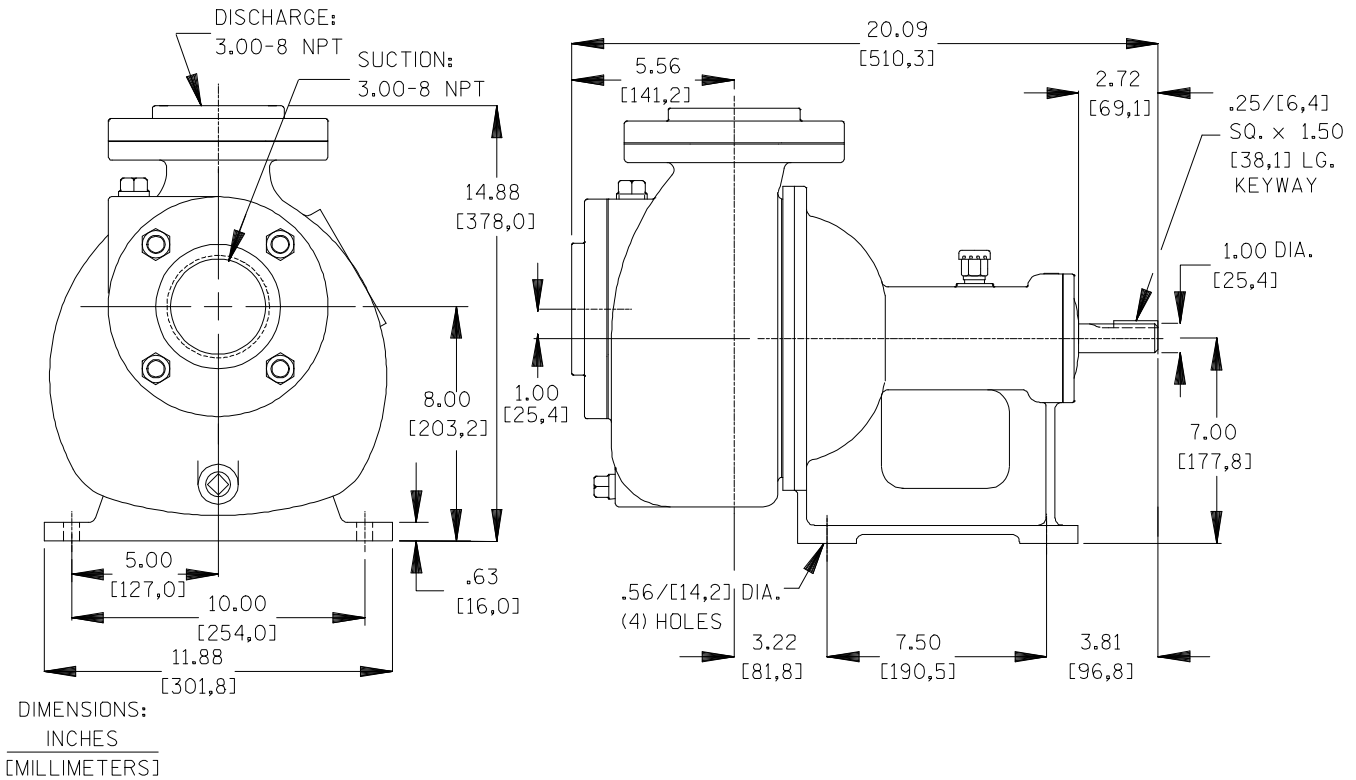

**PERFORMANCE
BASED ON
WATER**

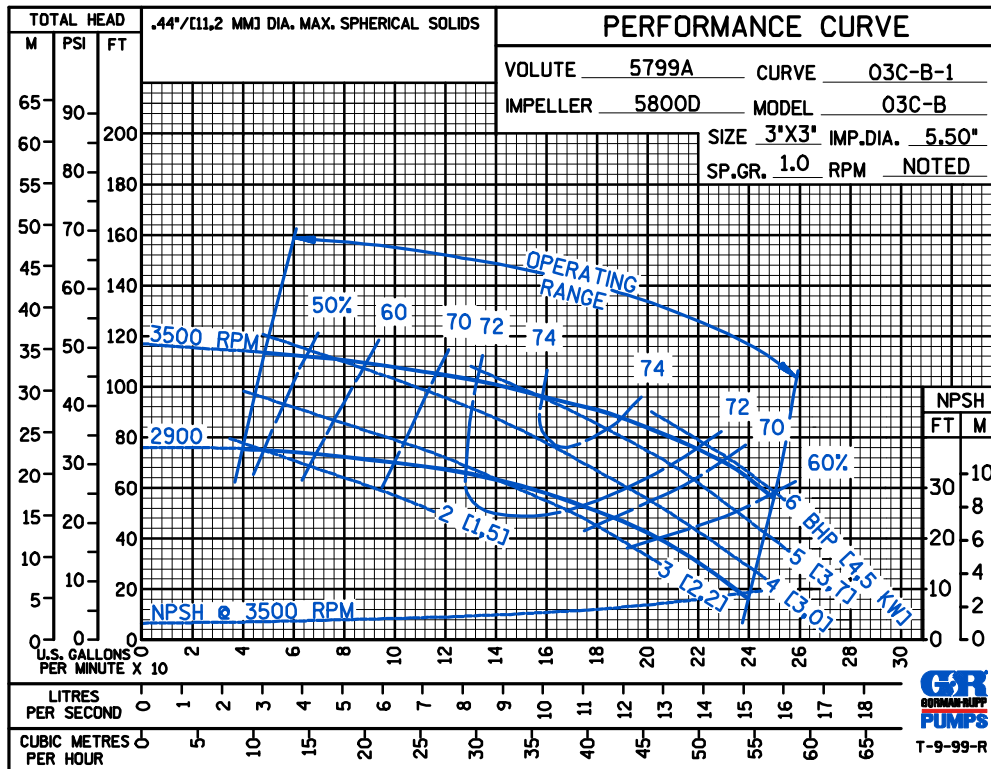

THE GORMAN-RUPP COMPANY • MANSFIELD, OHIO

GORMAN-RUPP OF CANADA LIMITED • ST. THOMAS, ONTARIO, CANADA

Specifications Subject to Change Without Notice

Printed in U.S.A.

B C

PERFORMANCE
BASED ON
PETROLEUM

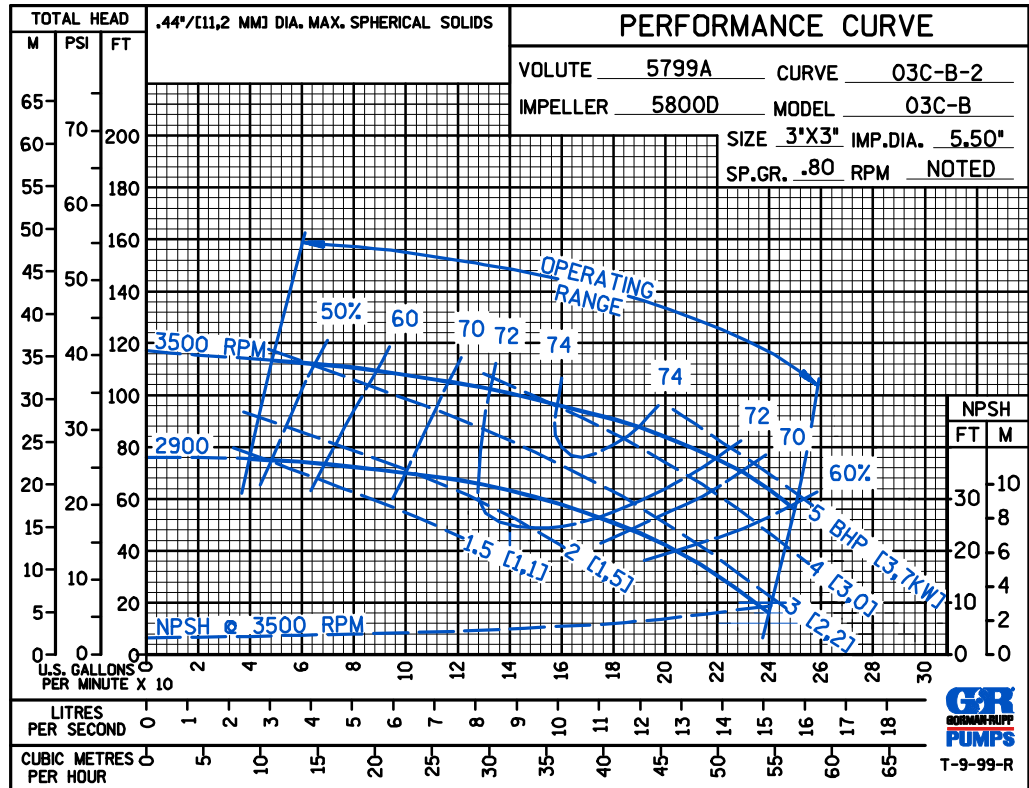

50 HERTZ
PERFORMANCE
BASED ON
WATER

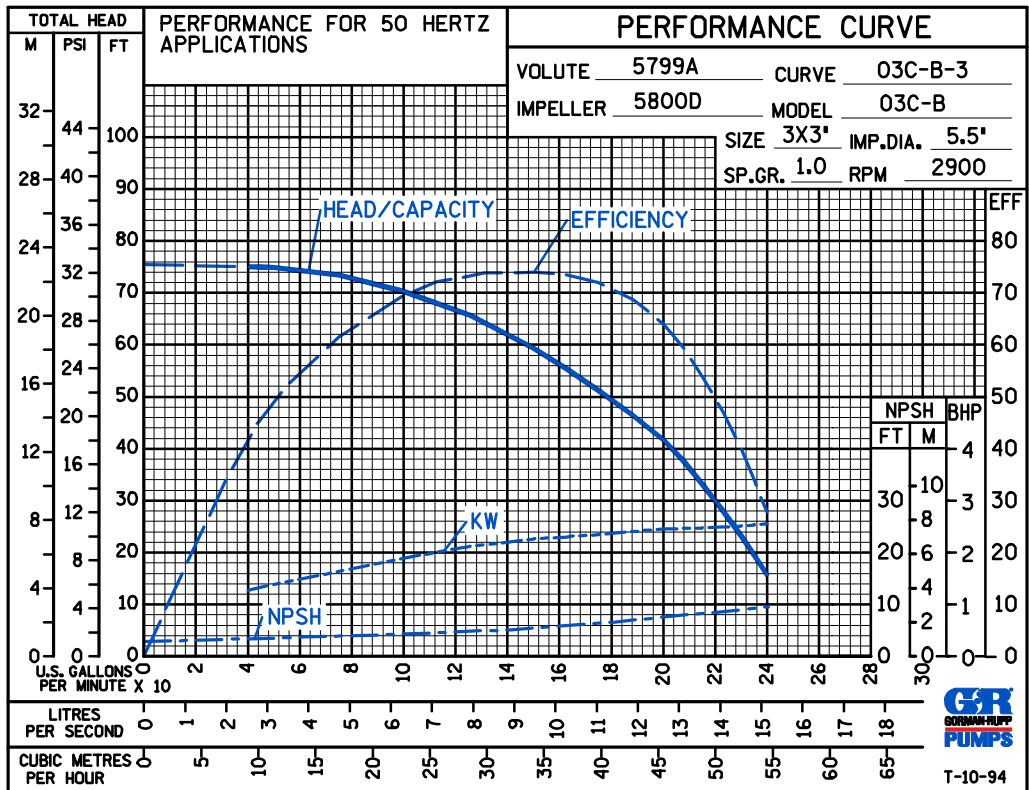

THE GORMAN-RUPP COMPANY • MANSFIELD, OHIO

GORMAN-RUPP OF CANADA LIMITED • ST. THOMAS, ONTARIO, CANADA

Specifications Subject to Change Without Notice

Printed in U.S.A.